

Declaration Type	Identifiers	Address	Type	Initial Value
------------------	-------------	---------	------	---------------

Network 1

Easy PLC Link Master 1 DVP12SA2 PLC Master 4 DVP PLC Slave
 Max_16 Slave

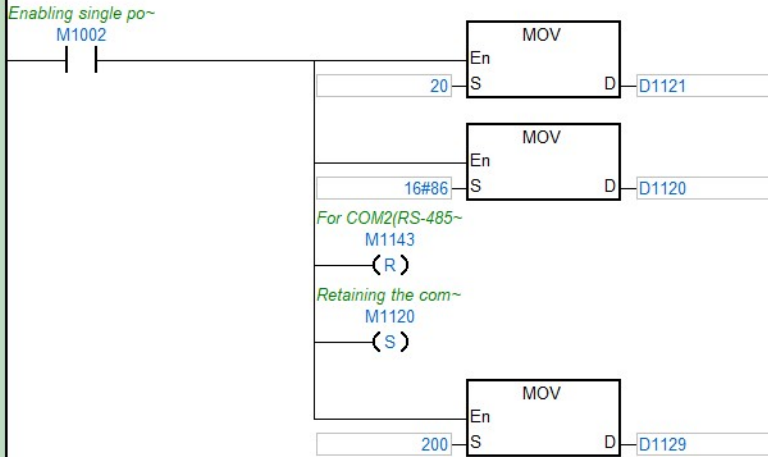

Network 2

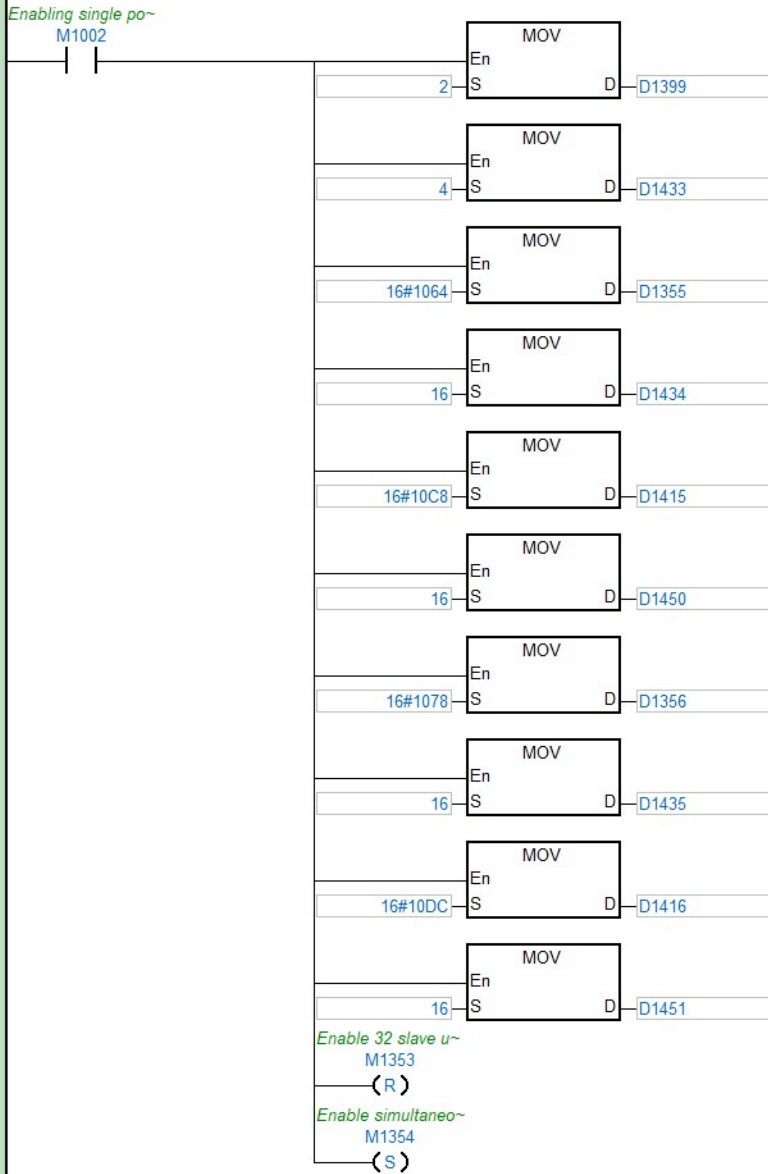

Network 3

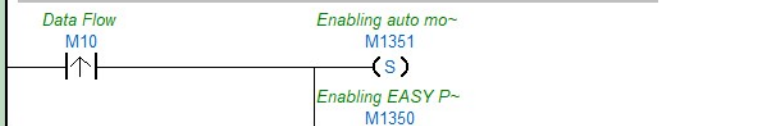

(S)

Network 4

HMI kijelzőn megjeleníthető Indikátorok

Slave ID#1 linking~
M1392

Coms Error
M0



Network 5

Slave ID#2 linking~
M1393

Coms Error
M1



Network 6

Slave ID#3 linking~
M1394

Coms Error
M2



Network 7

Slave ID#4 linking~
M1395

Coms Error
M3



Network 8

Indicating Slave I~
M1376

Data Flow
M10



Network 9

Indicating Slave I~
M1377

Data Flow
M11



Network 10

Indicating Slave I~
M1378

Data Flow
M12



Network 11

Indicating Slave I~
M1379

Data Flow
M13

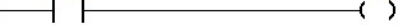

Network 12

Slave ID#1 status ~
M1360

Status On
M20



Network 13

Slave ID#2 status ~
M1361

Status On
M21



Network 14

Slave ID#3 status ~
M1362

Status On
M22



Network 15

Slave ID#4 status ~
M1363

Status On
M23



Network 16

Indicating writing t~
M1424

Writing Ok
M30



Network 17



Network 18

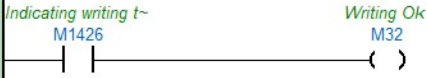

Network 19



Network 20

Adatforgalmi regiszterek Slave_1

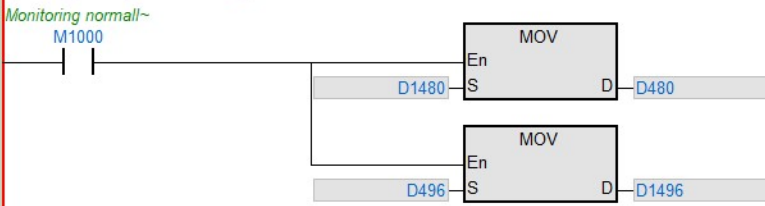

Network 21

Slave_2

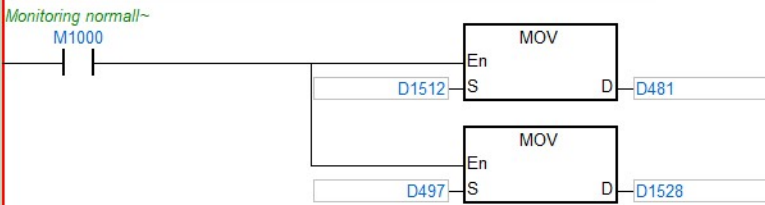

Network 22

Slave_3

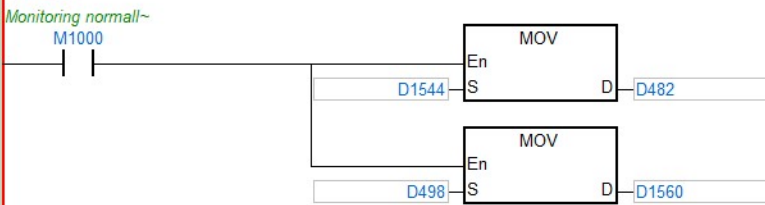

Network 23

Slave_4

